

PSA MODULES WIRING DIAGRAMS

#PSA BSI CONTINENTAL SC667050+95256 CAN BSI-Q0x-00

#PSA BSI SIEMENS/CONTINENTAL 1L00M+95128/95256 CAN BSI-S0x-00

#PSA BSI SIEMENS/CONTINENTAL 76F0018+95160 KLINE BSI-F0x-00/BSI-E0X-00

#PSA BSI VALEO 4L00M+95128/25128 CAN (BSI2004-P0X-00)

#PSA BSI VALEO 2M48H+24C128 CAN (BSIEV-X0X-00)

#PSA BSI VALEO SC667152+95256 CAN BSI-N0x-00

#PSA BSI JC easyCAN4+29LV400BB+95128 CAN (BSI2004-H0X)

#PSA BSI JC easyCAN4F1M32+95128 CAN (BSI04EV-K0X)

OBD CABLE FOR PSA BSI

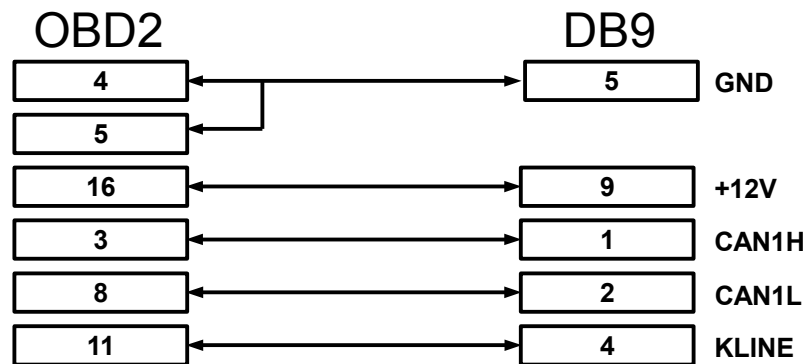

PSA BSI CONTINENTAL SC667050+95256 CAN #BACK BSI-Q0x-00

Microcontroller – SC667050
EEPROM - 95256

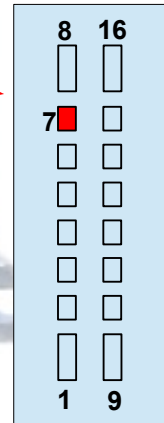
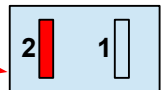
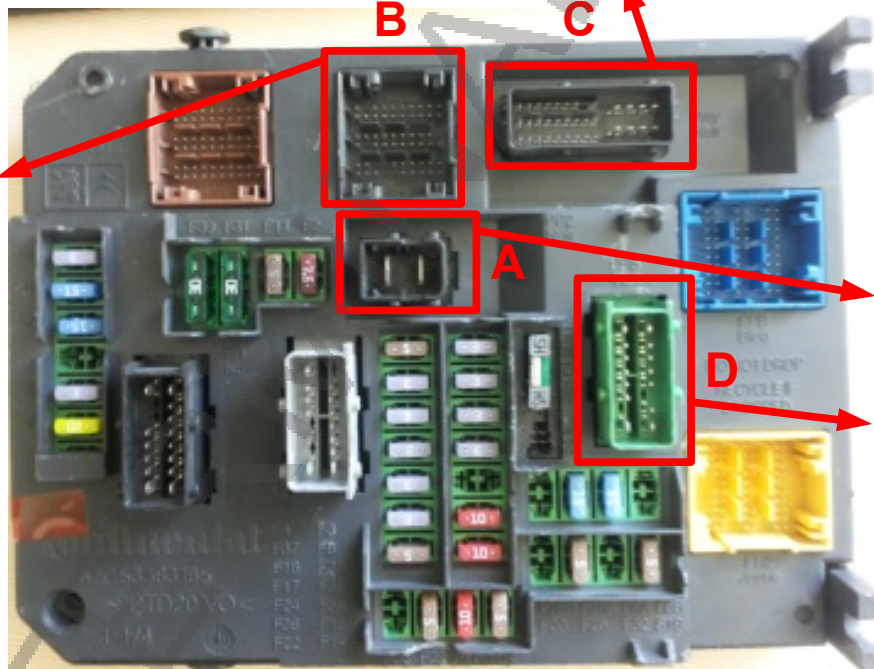
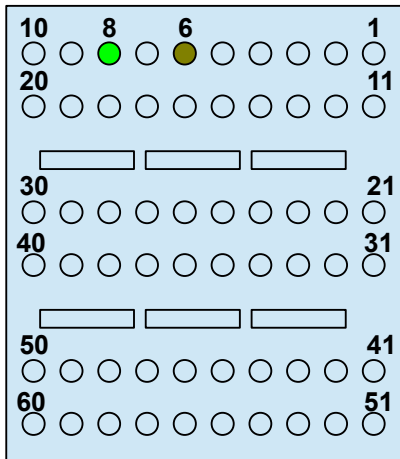
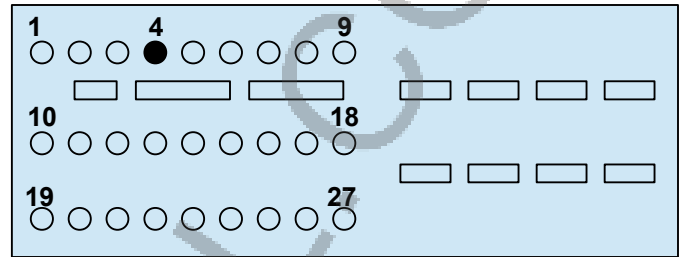

+12V	GND	CANH	CANL
A2, D7	C4	B6	B8

Connecting directly to ioterminal

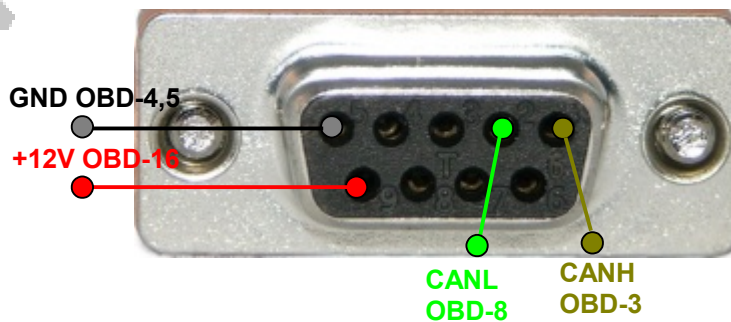

PSA BSI SIEMENS/CONTINENTAL 1L00M+95128/95256 CAN BSI-S0x-00 #BACK

Microcontroller – 1L00M (9S12DP512)

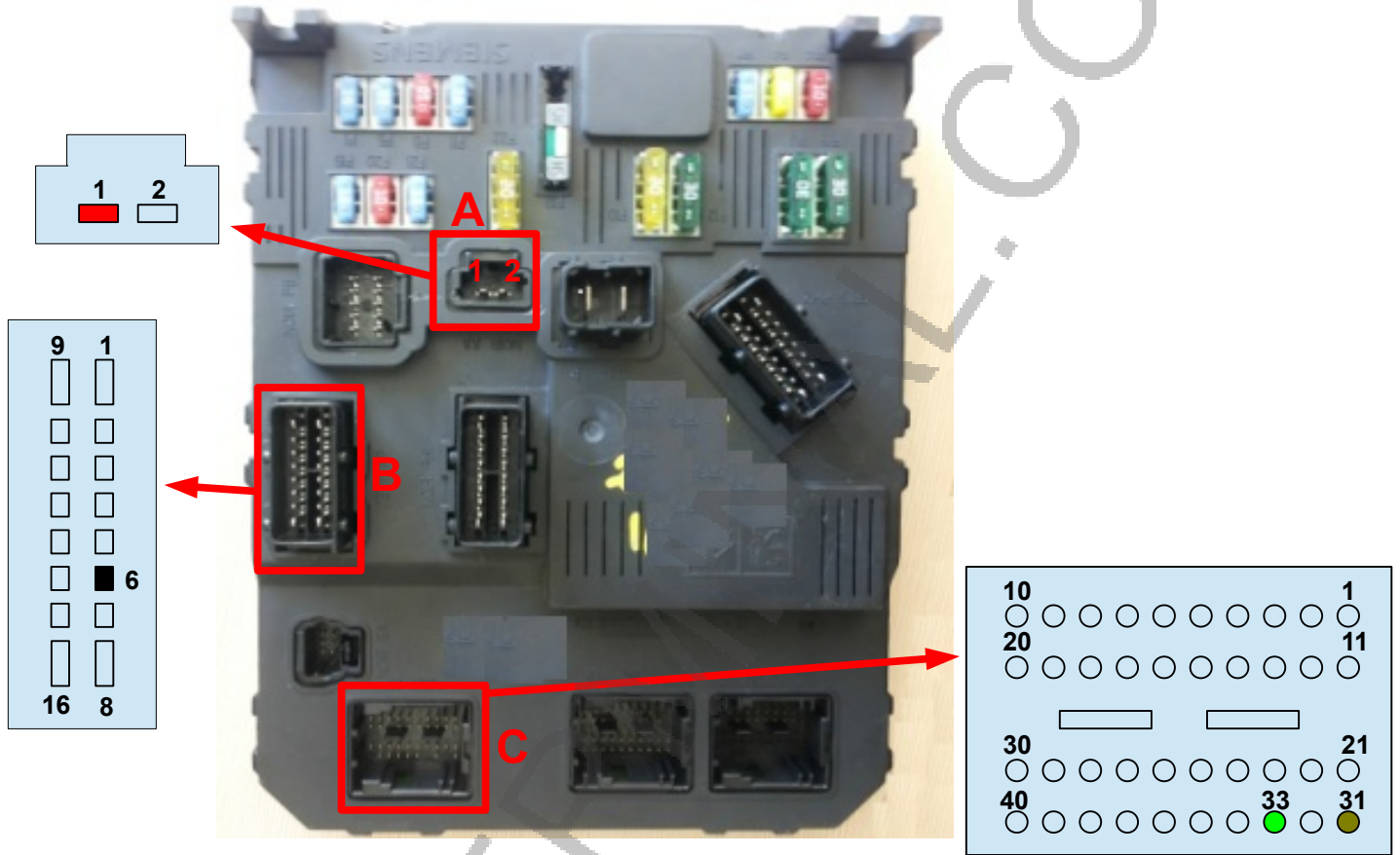

+12V	GND	CANH	CANL
A1	B6	C31	C33

Connecting directly to ioterminal

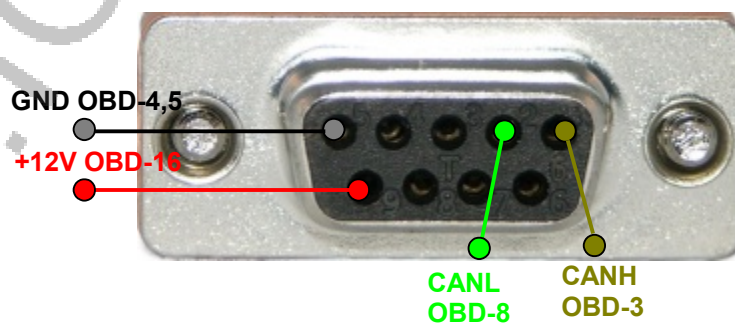

PSA BSI SIEMENS/CONTINENTAL 76F0018+95160 KLINE BSI-F0x-00/BSI-E0X-00 #BACK

Microcontroller – 76F0018
EEPROM - 95160

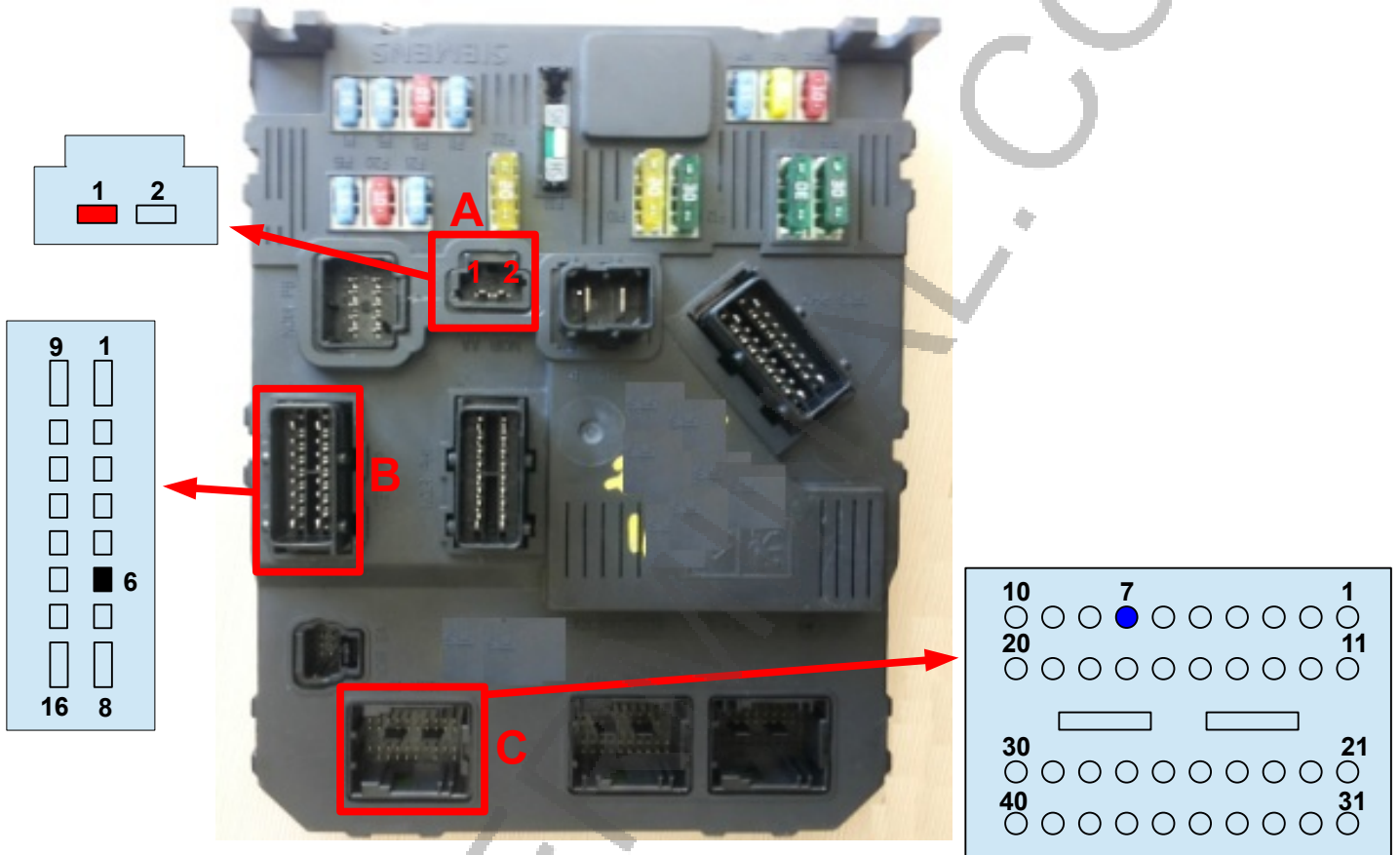

+12V	GND	KLINE
A1	B6	C7

Connecting directly to ioterminal

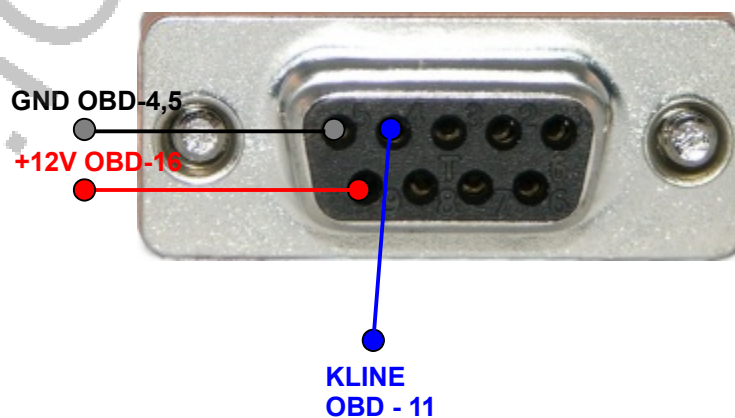

PSA BSI VALEO 4L00M+95128/25128 CAN (BSI2004-P0X-00)

Microcontroller – 4L00M (9S12DP512)
EEPROM – 95128/25128

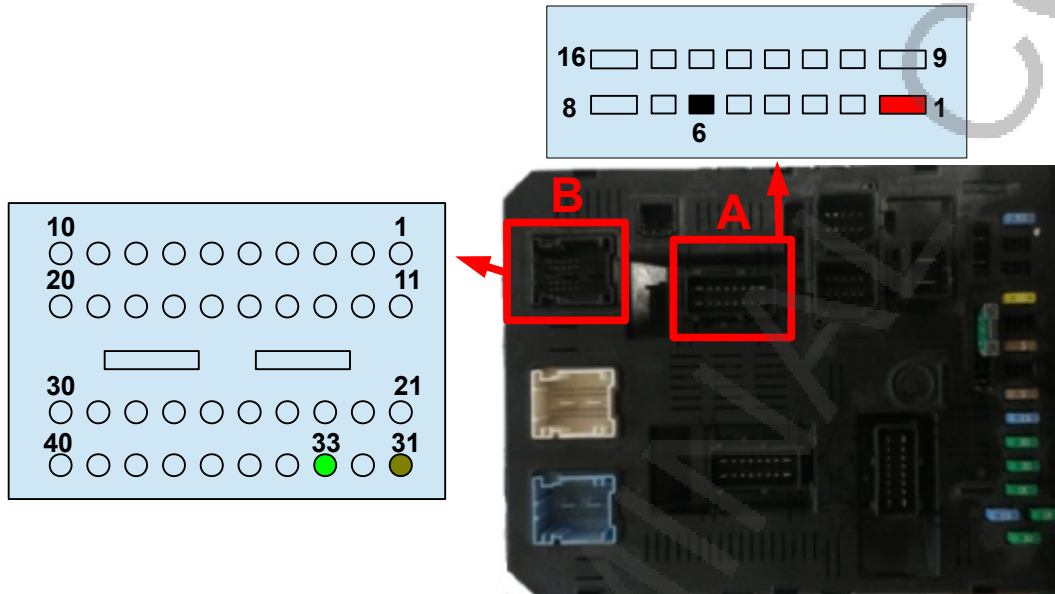

+12V	GND	CANH	CANL
A1	A6	B31	B33

Connecting directly to ioterminal

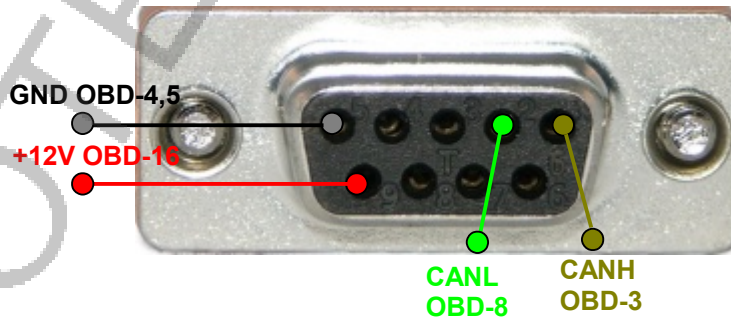

PSA BSI VALEO 2M48H+24C128 CAN (BSIEV-X0X-00)

Microcontroller – 2M48H (9S12XEP768)
EEPROM – 24C128

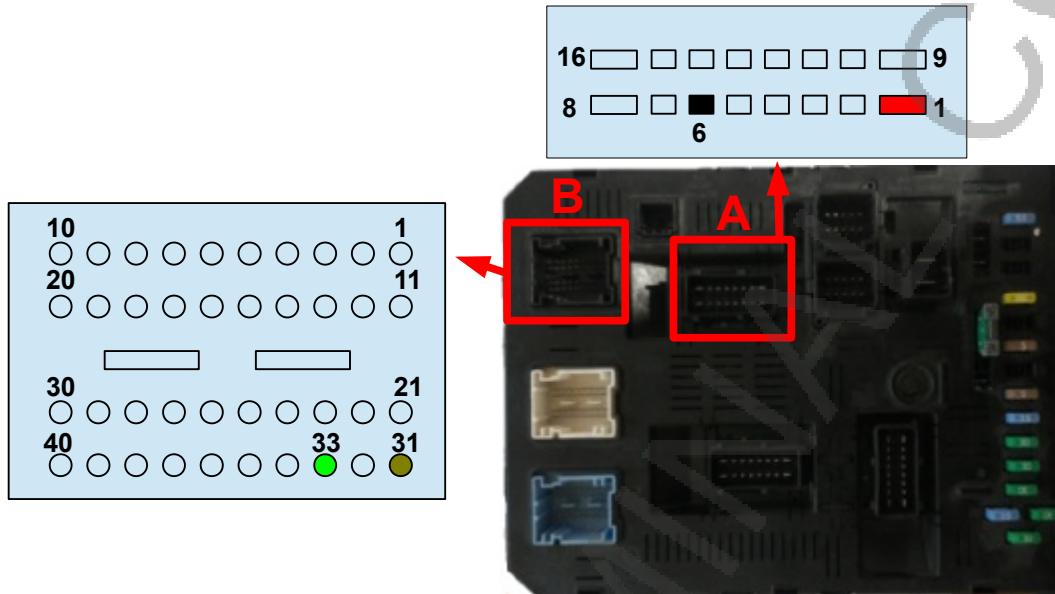

+12V	GND	CANH	CANL
A1	A6	B31	B33

Connecting directly to ioterminal

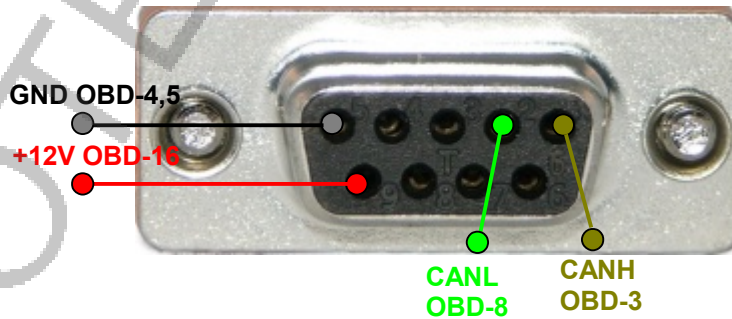

PSA BSI JC easyCAN4+29LV400BB+95128 CAN (BSI2004-H0X)

Microcontroller – easyCAN4
Flash - 29LV400BB
EEPROM – 95128

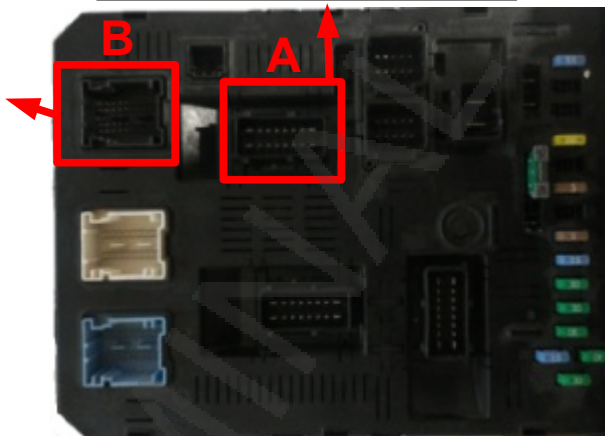
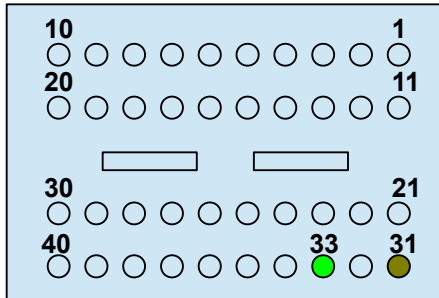
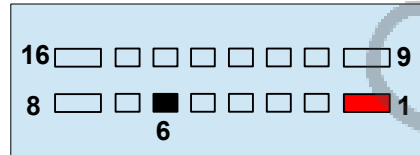

+12V	GND	CANH	CANL
A1	A6	B31	B33

Connecting directly to ioterminal

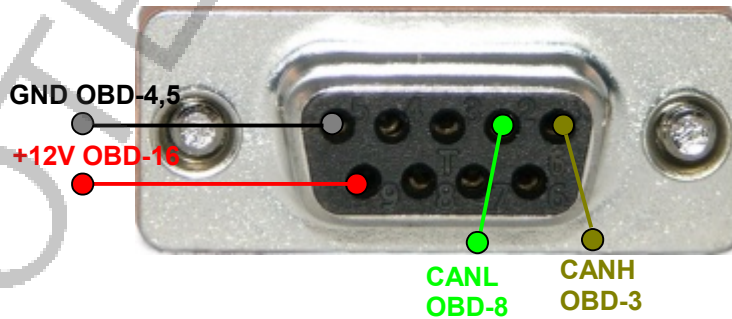

PSA BSI JC easyCAN4F1M32+95128 CAN (BSI04EV-K0X)

Microcontroller –
easyCAN4F1M32
EEPROM – 95128

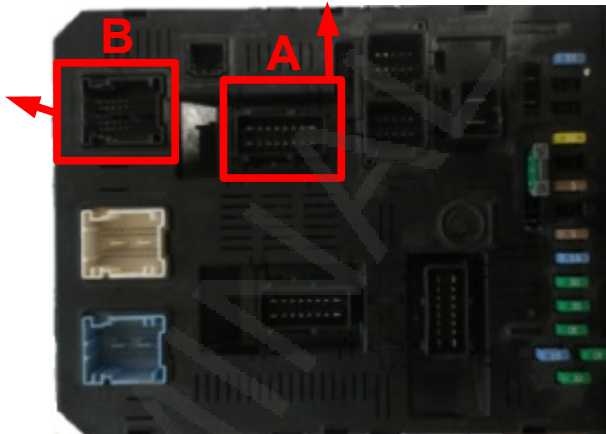
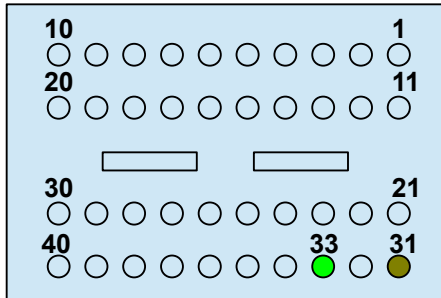
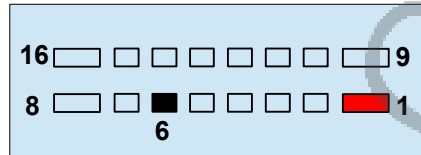

+12V	GND	CANH	CANL
A1	A6	B31	B33

Connecting directly to ioterminal

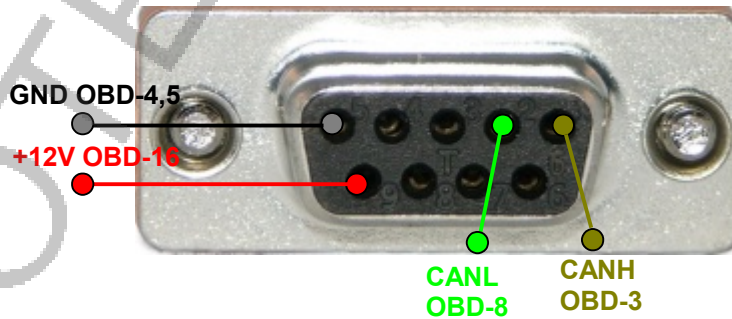

PSA BSI VALEO SC667152+95256 CAN BSI-N0x-00

#BACK

Microcontroller – SC667152
EEPROM - 95256

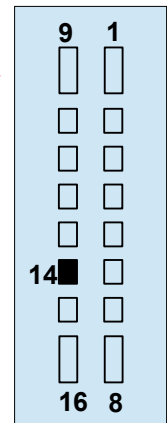
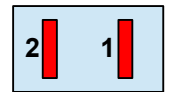
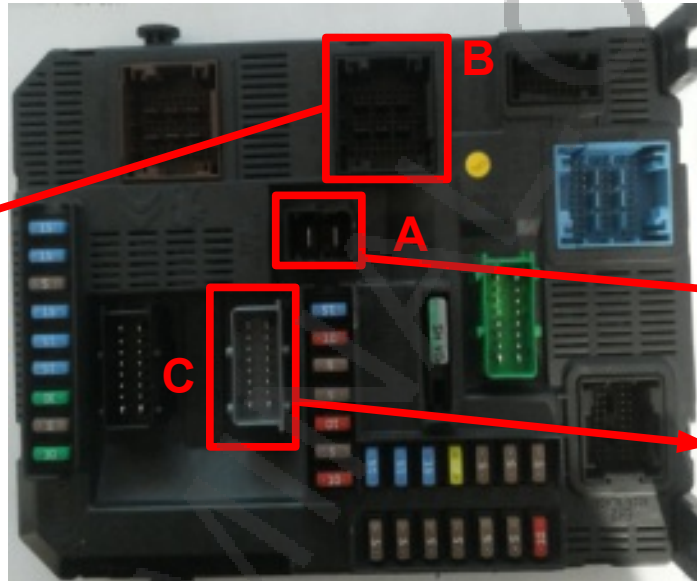
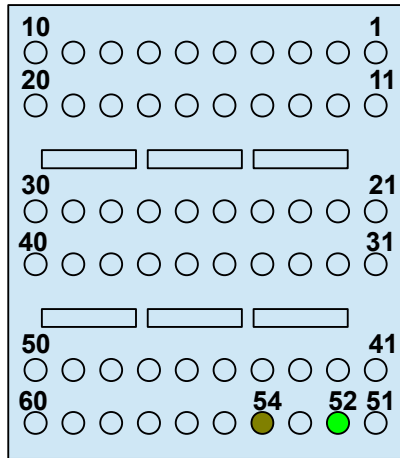

+12V	GND	CANH	CANL
A1, A2	C14	54	52

Connecting directly to ioterminal

