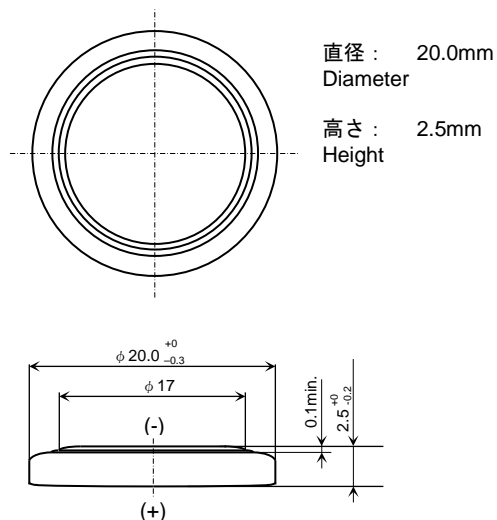
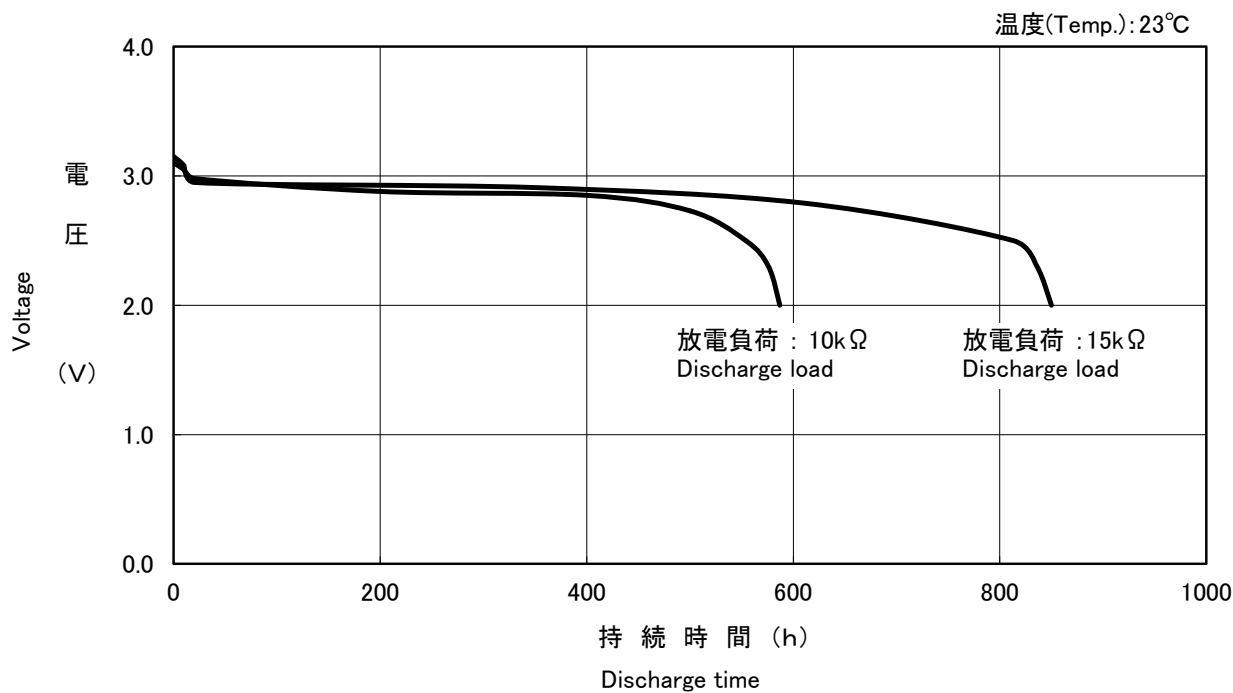

コイン形二酸化マンガンリチウム電池  
 Coin manganese dioxide lithium batteries

# CR2025

**■外形寸法** Dimensions(mm)

**■定格** Specifications

公称電圧 Nominal Voltage	3V
公称容量 (終止電圧 2.0V) Nominal Capacity (2.0V cutoff)	160mAh
標準放電電流値 Standard Discharge Current	0.2mA
標準質量 Weight	2.6g
<b>用途 Applications</b> <ul style="list-style-type: none"> <li>● 時計 ● リモートコントローラー ● 電子ゲーム・玩具</li> <li>● SRAMやリアルタイムクロック等メモリーバックアップ</li> <li>● Electronic Watch or Clock</li> <li>● Remote Controller</li> <li>● Electric Game, Toy</li> <li>● Memory Back-up Power Source for SRAM or Real Time Clock (RTC)</li> </ul>	

**■放電特性** Discharge Characteristics

■放電負荷特性

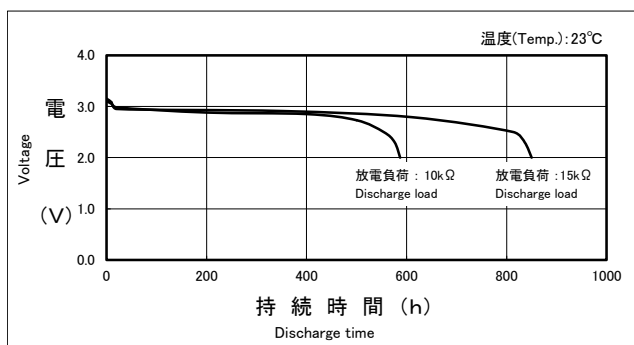
Discharge Characteristics on Load



■放電温度特性

Discharge Characteristics on Temperature

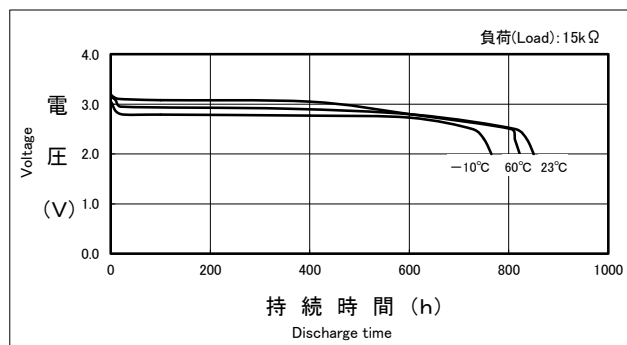

■放電負荷と作動電圧 (放電深度 40%時の電圧)

Discharge Load vs. Operation Voltage (Discharge depth 40%)

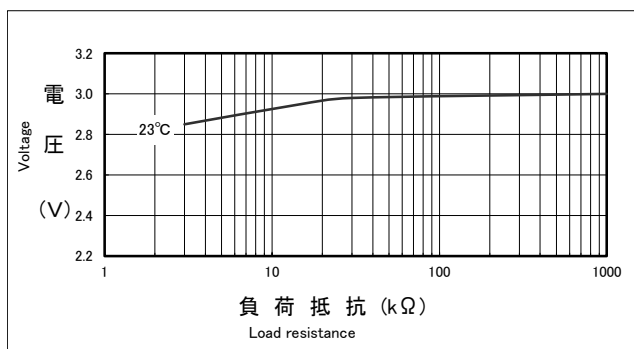

■放電負荷と電気容量

Discharge Load vs. Discharge Capacity

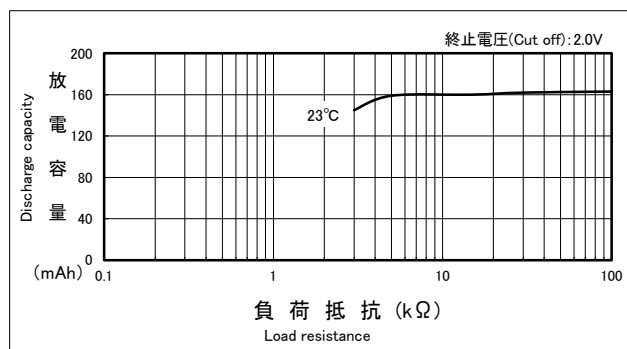

■パルス放電特性 (放電深度 40%時のパルス電圧)

Discharge Characteristics on Pulse Load (Discharge depth 40%)

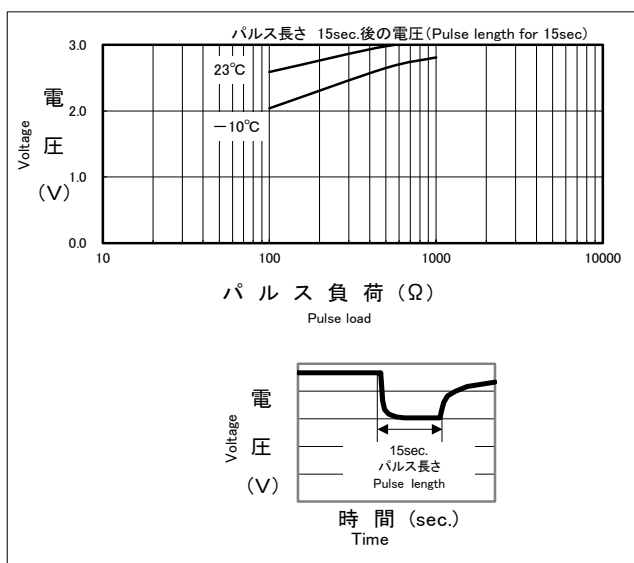

■保存特性

Storage Characteristics

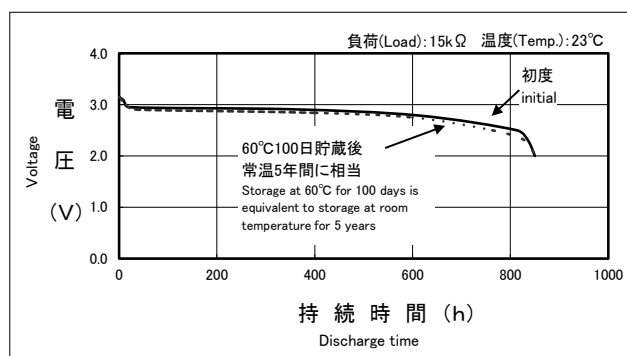

\*記載のデータ及び数値は、参考値であり保証値ではありません。

\*Data is not guaranteed, and is provided for reference purposes only.